

BUIGSTAAT MET BUIGVORMEN									
Posnr	Diameter	Aantal	Kwaliteit	Lengte	Gewist	Gewicht	Buigvorm	Commentaar	
K8	20	4	B500B	7370	18.20	72.8	7370		
K9	16	8	B500A	7370	11.64	93.2	7370		
BG3	8	64	B500A	1684	0.67	42.6	110 390		
CONS9	8	6	B500A	2884	1.14	6.8	110 390		
CONS35	8	8	B500A	1914	0.76	6.1	110 370		
CONS37	16	6	B500A	2730	4.31	25.9	524 539		TE BINDEN
K11	16	4	B500A	1891	2.99	12.0	970		TE BINDEN
Totaal staven:						259.3			

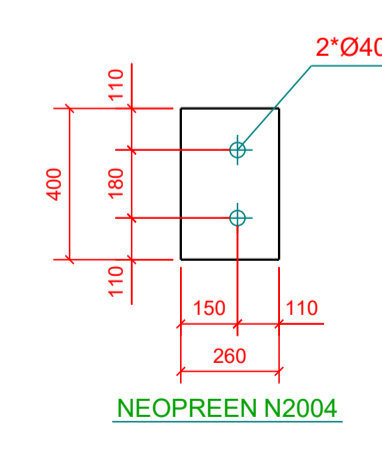
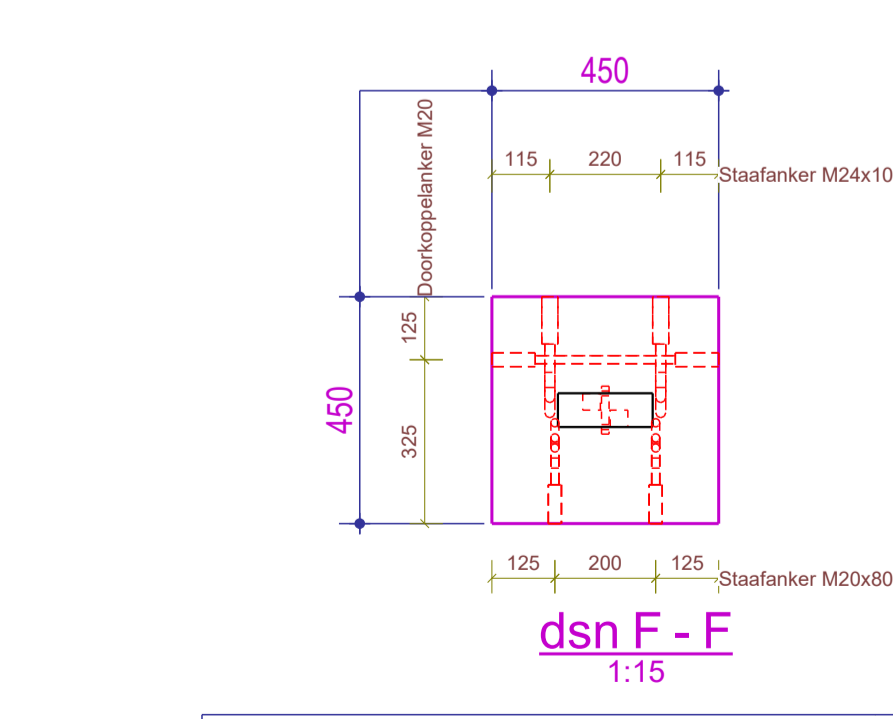
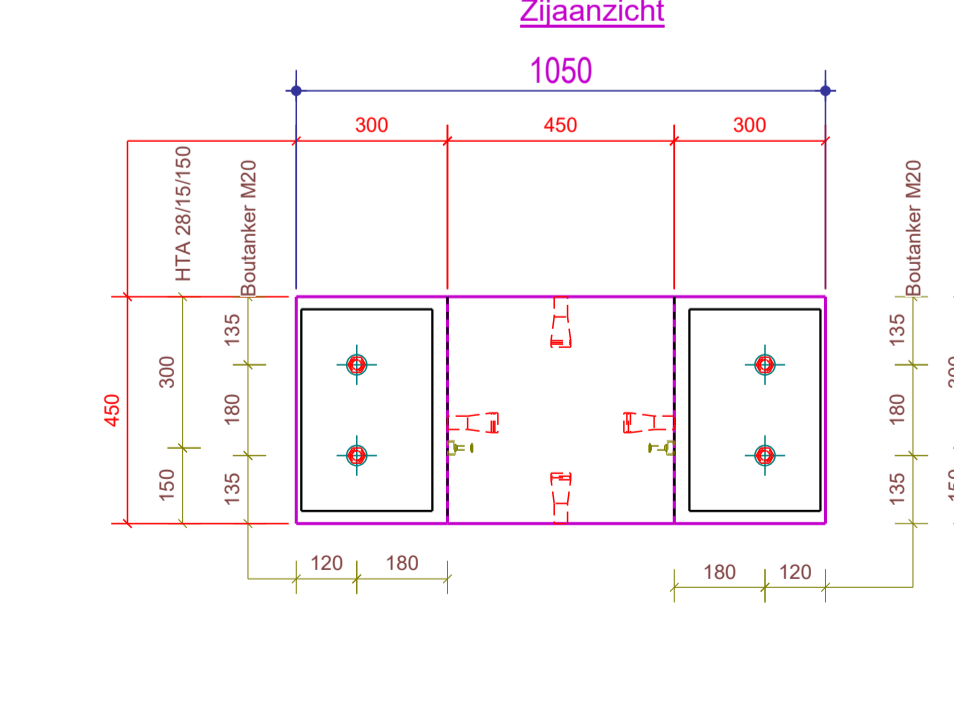
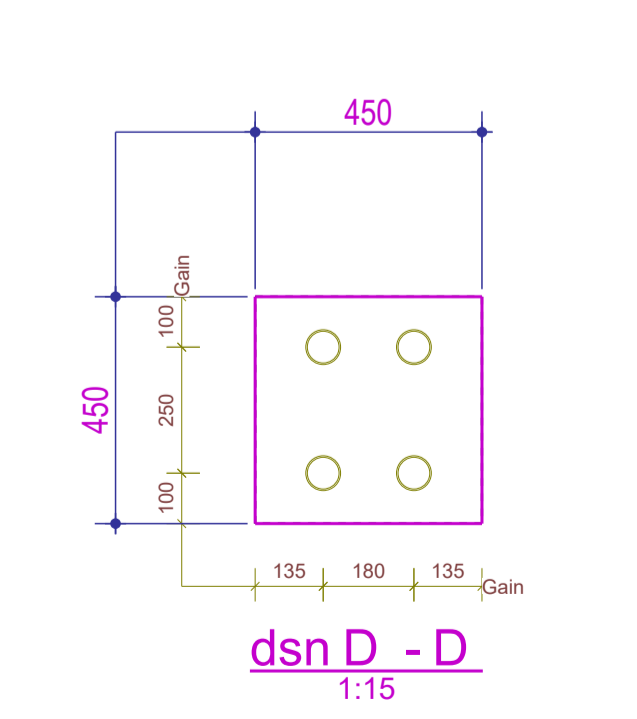
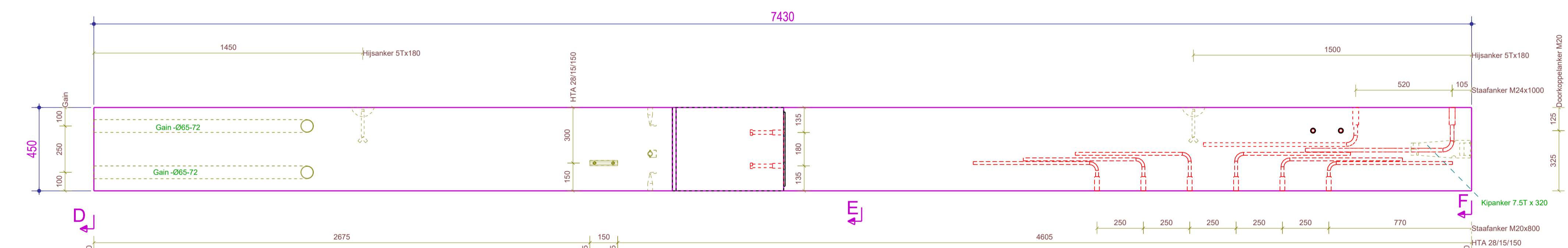
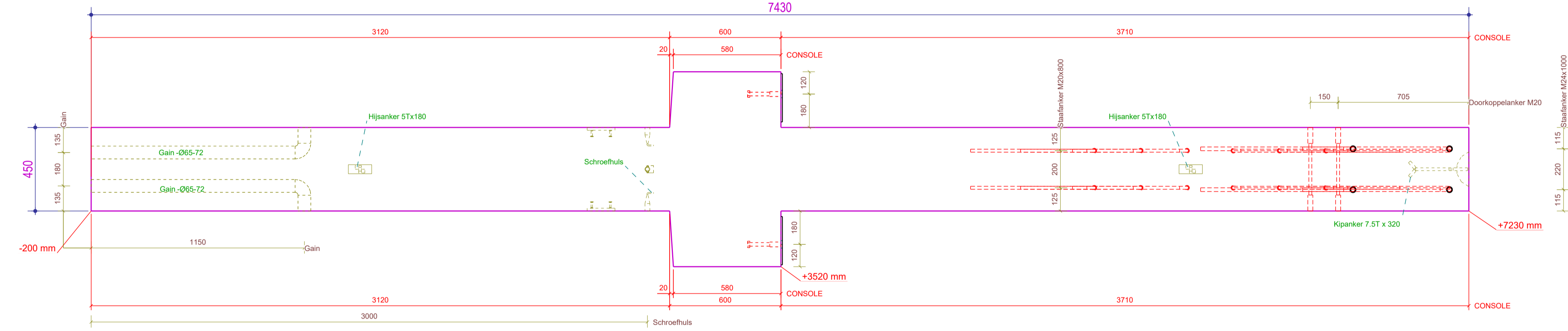
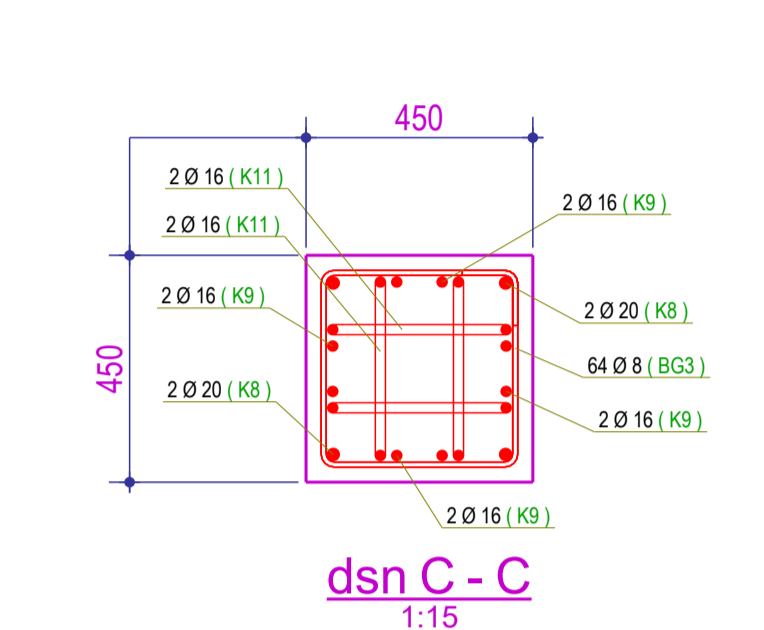
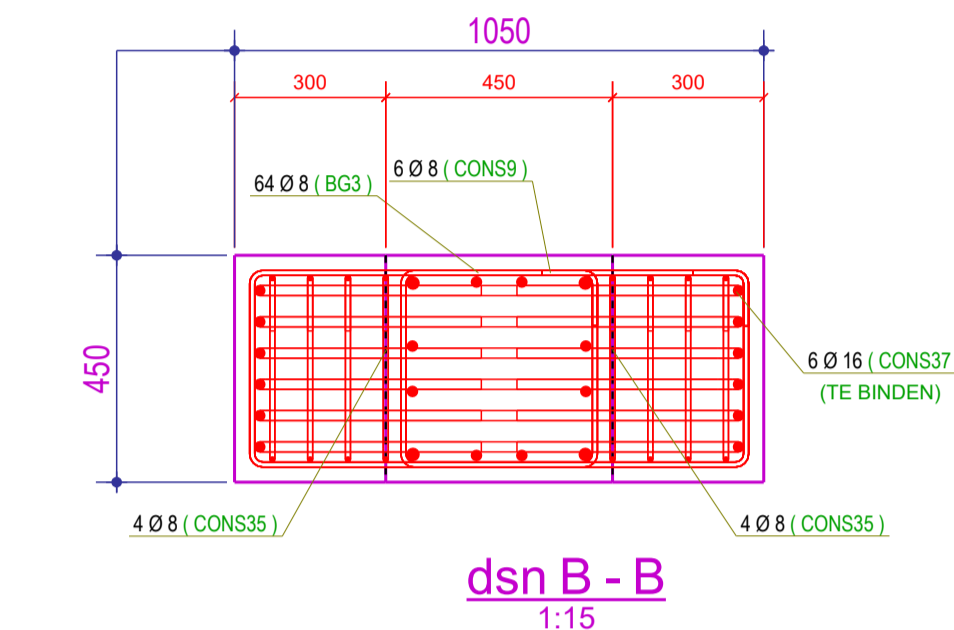
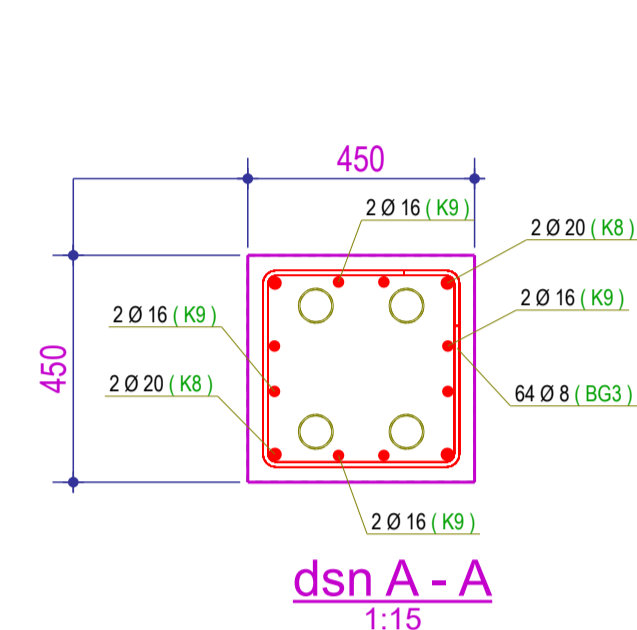
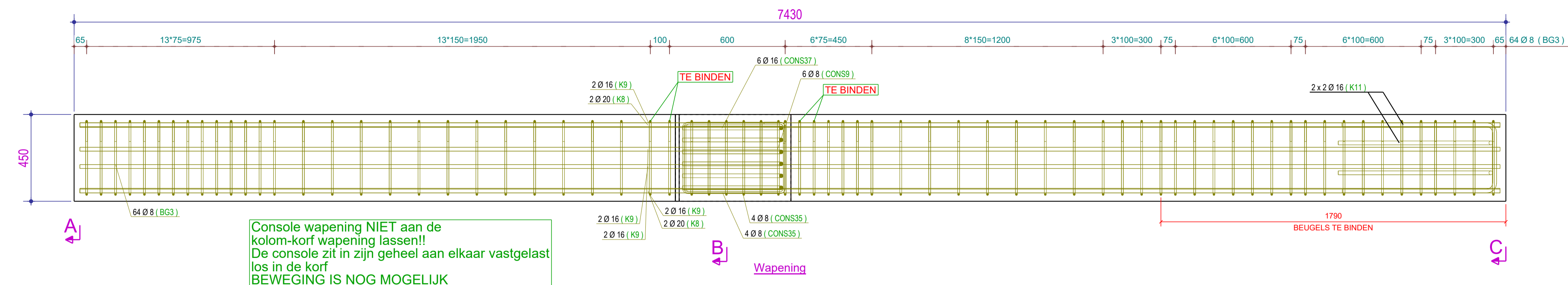

Pos	Instortvoorzieningen (profiel x lengte)	Aantal
G03	Gain -Ø65-72x1264	4
N2004	NEOPREEN FLAT8-100x200	2
PSAD4	Doorkoppelanker M20 - Ø16/M20x450 - bus electr. vz	2
PSAG3	Staaanker M24x1000 - Ø20/M24x1000 - bus electr. vz	2
PSAG8	Staaanker M20x800 - Ø16/M20x800 - bus electr. vz	4
PSAG9	Staaanker M20x800 - Ø16/M20x800 - bus electr. vz	4
PSAG10	Staaanker M20x800 - Ø16/M20x800 - bus electr. vz	4
PSAG11	Staaanker M24x1000 - Ø20/M24x1000 - bus electr. vz	2
KA1	Kipanker 7.5T x 320	1
BA1	Boutanker M20 M20x180	4
DT	Schroefhuis M20x100	4
H3	Hijssanker 5Tx180	2
HTA3	HTA28/15x150	2
Totaal:		35

afwijkende inplanting gaines

Element nummers	
BK34	
Opdrachtgever: Delhaize	Adres: 'S Herebaan 178 B, 2840 Reet
Delhaize Reet	
Werknummer: 2017-0189	
BSV nummer:	
Kwaliteit: C30/37	Omgevingsklasse: E2
Dikte: 450 mm	Milieuklasse: X B
Lengte: 7430 mm	Volumem³: 1.66
Hoogte: 450 mm	Gewicht (kg): 4054