

** Deling met bouwverbinding

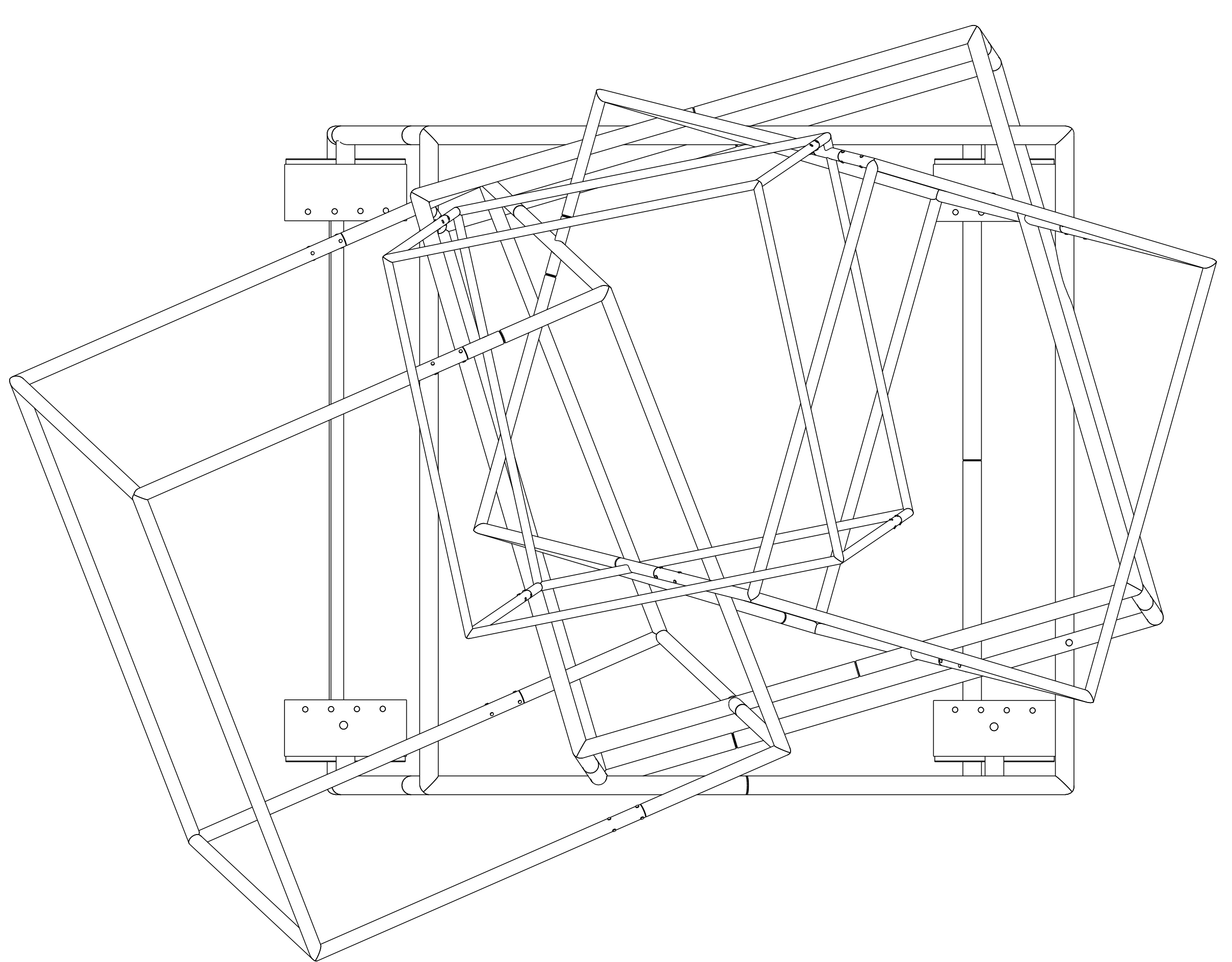

Bovenaanzicht
1:30

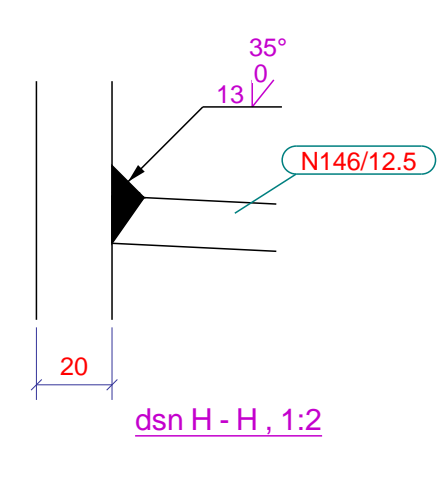
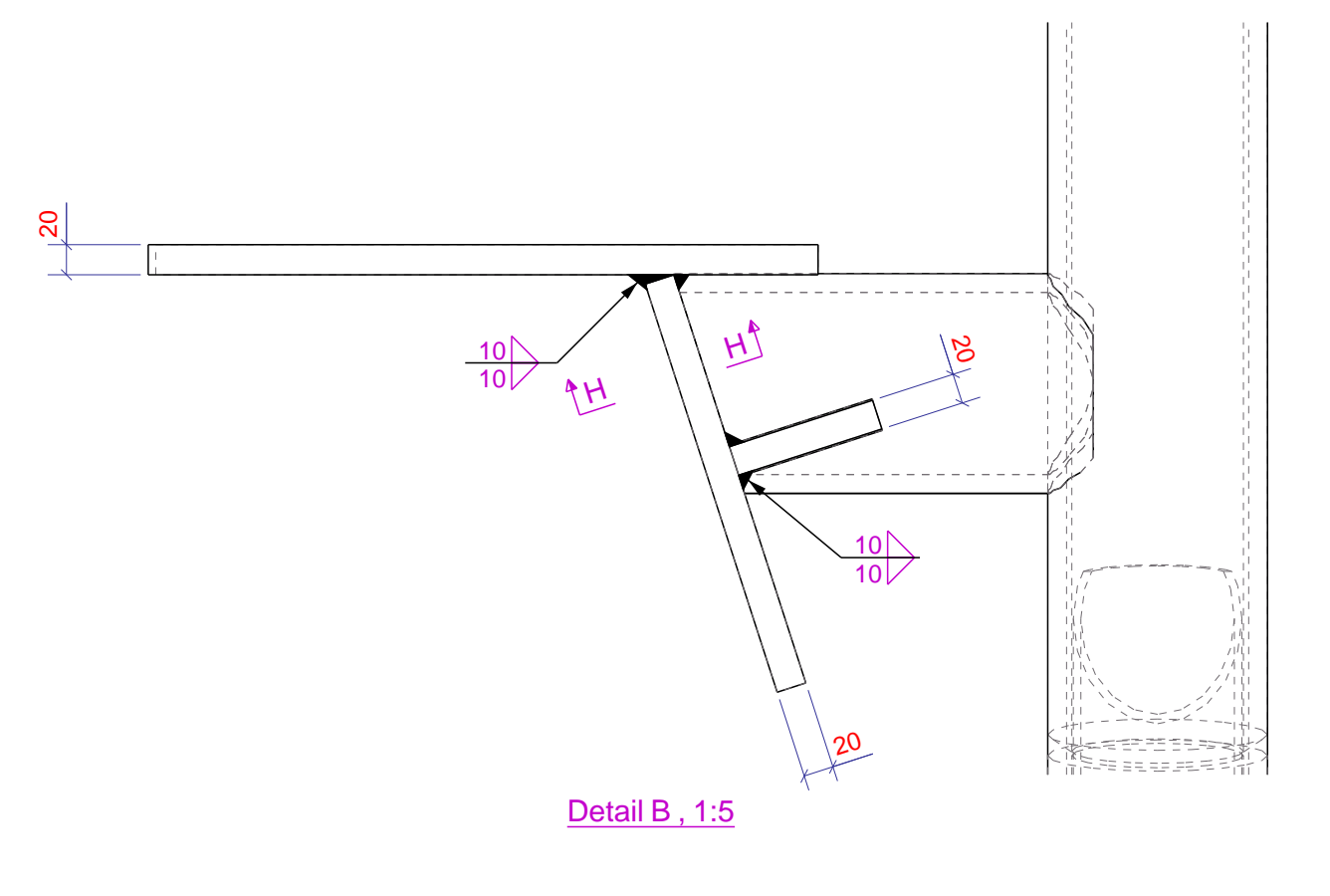
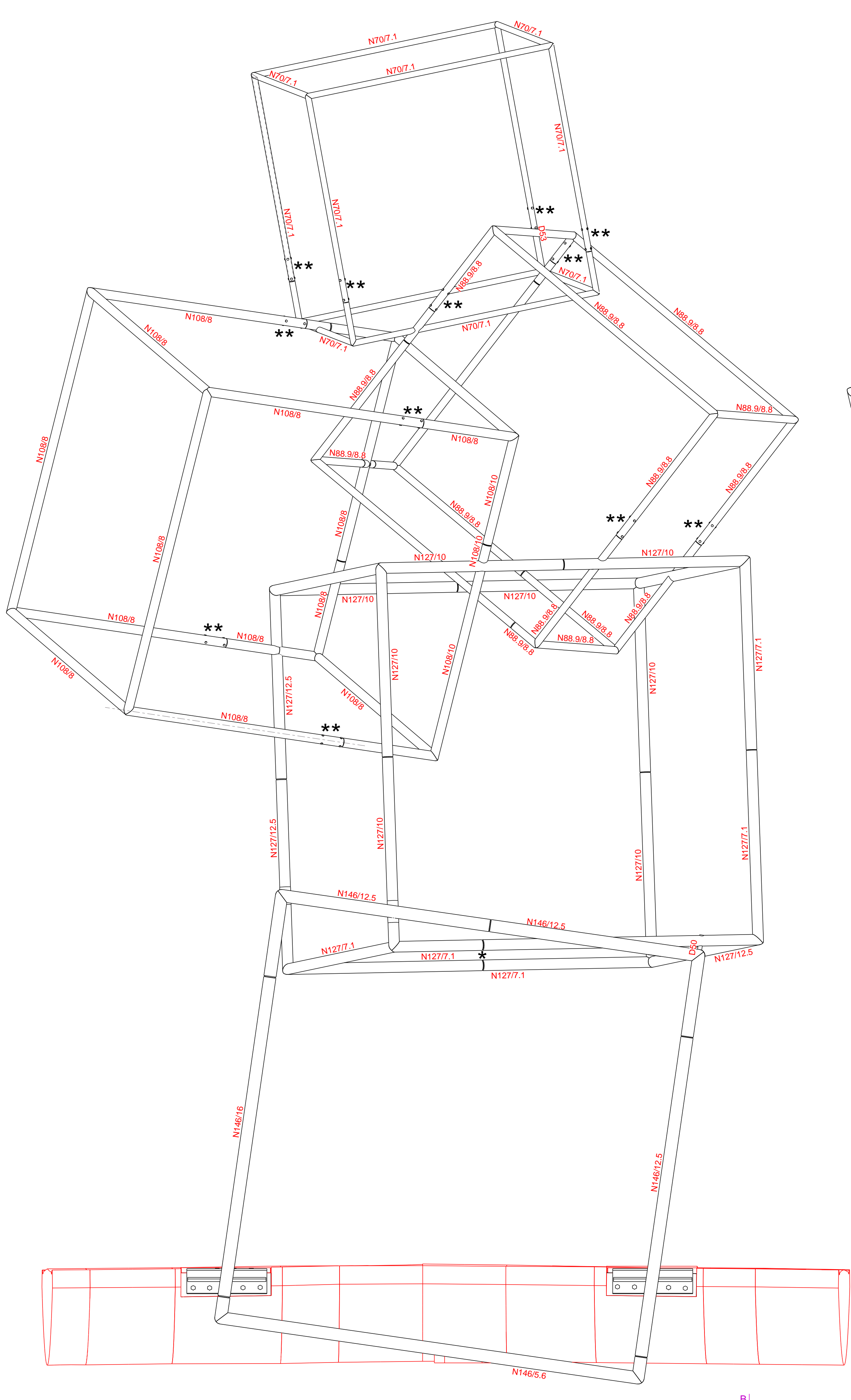

Voor aanzicht

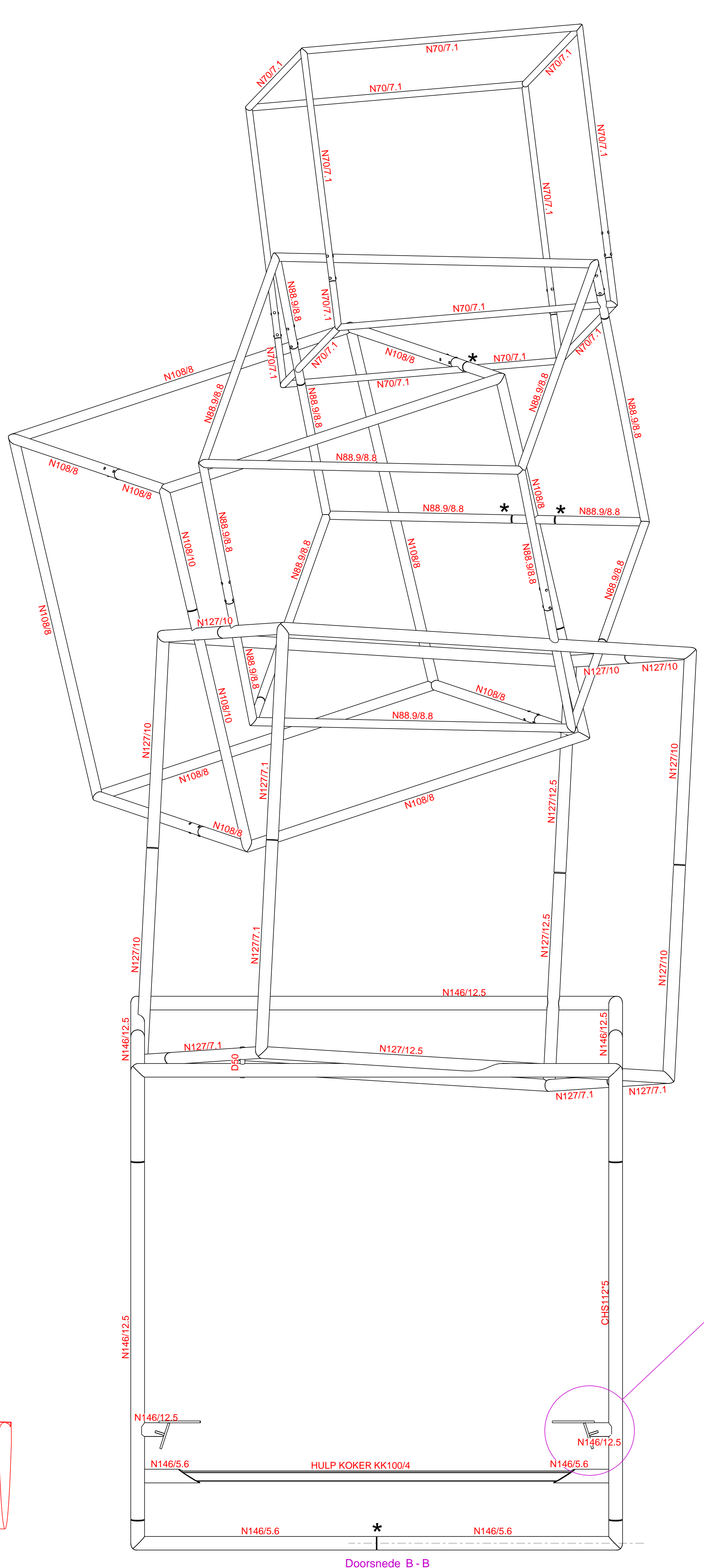

Doorsnede B - B

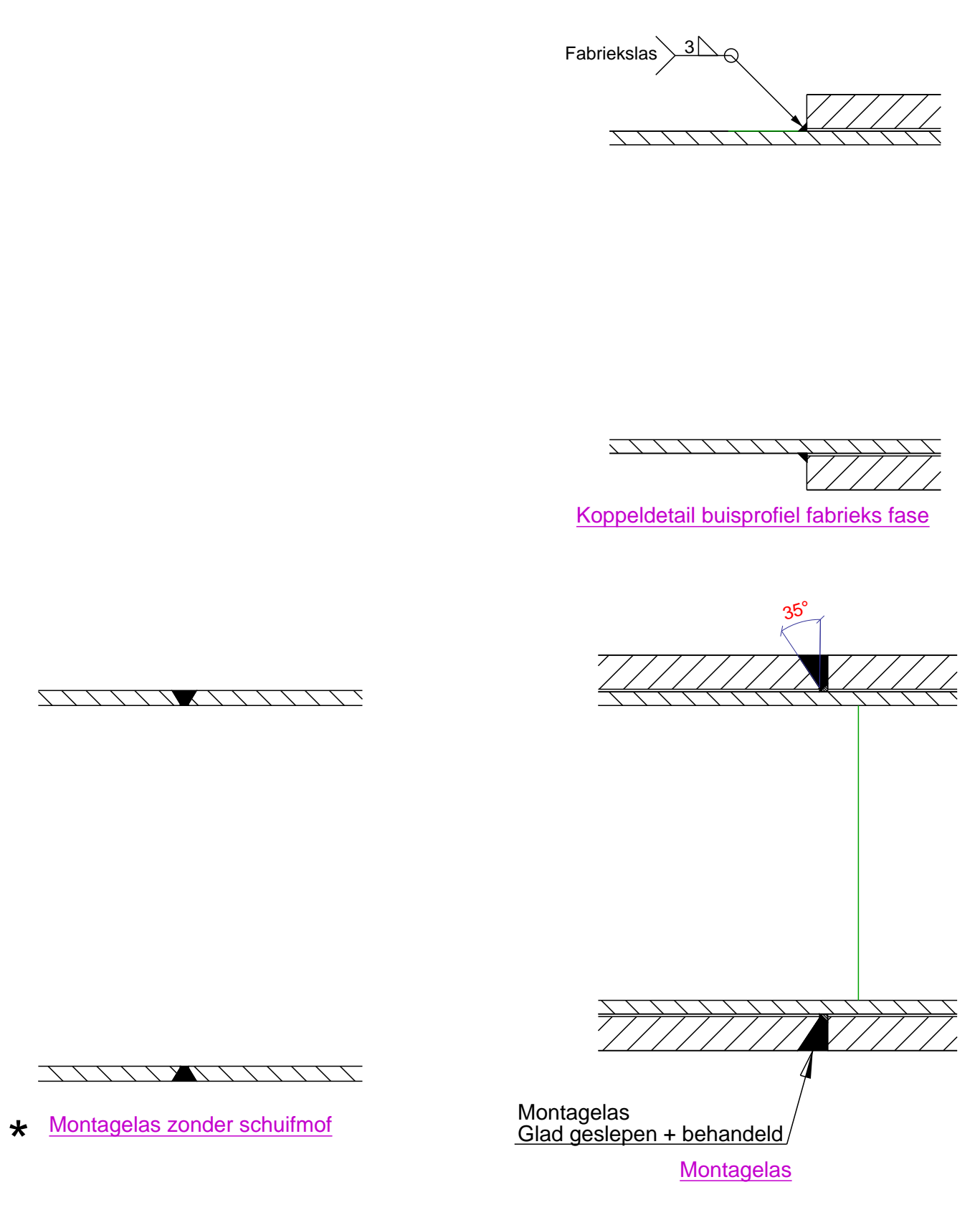

* Montagelas zonder schuifmof

Montagelas Glad geslepen + behandeld

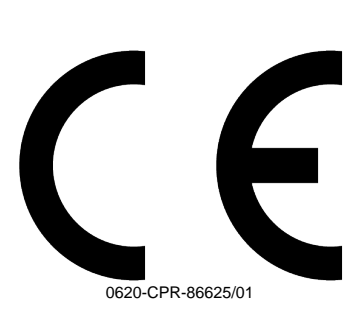

| | |
|--|------------------------------|
| Rev. no. Revisie datum Revisie omschrijving | Tek |
| Conservering: Stralen Sa 2,5 en Schooperen Monopox Metaalsealer - 80mg Monopox ZF Universal - 100mg Polyfinish HS 65-75 - 70mg eind kleur RAL5015 Materiaalsoorten en kwaliteiten: Platen en profielen S355J2H (L+V) volgens NEN-EN 10025-2. buis en kokerprofielen: S355J2H volgens NEN-EN 10219-1 (koudvervaardigd) L+V. Lassen a-w4, tenzij anders vermeld, volgens NEN-EN-ISO 2553:2014. Boutwalleit 8.8, tenzij anders vermeld. Fabricage en montage volgens NEN-EN 10962:2008+A1:2011 Uitvoeringsklasse: EXC3 Functionele tolerantie klasse: 1 Tekening omschrijving: | |
| Projectie: | 1 |
| Opdrachtgever: | Provincie Limburg |
| Werk: | Kunstwerk de Lotusbloem N274 |
| Adres: | N274 Nabij Schinveld |
| Datum: | 10.01.2019 |
| Schaal: | 1:2 1:5 1:30 |
| Formaat: | 84x1089 |
| Project: | 3114-1 |
| Tekening: | G [5] |
| Status: | |
| Ref. extern: | |