

Vooraanzicht

Binnenblad: C50/60	netto opp.: 4.6 m ²	V = 1.12 m ³
Binnenblad: C50/60	netto opp.: 7.7 m ²	V = 1.84 m ³
Buitenblad: Anthraciet nr. 180	V = 0.23 m ³	
Isolatie:	PIR 022 / 100 mm	
Isolatie:	PIR 022 / 240 mm	

TOEBEHORENLIJST		
PSA Ø16/M20	600mm	2
Stabox 45S1 Ø8/150	1250mm	5
VV1	330mm	1
VV4	330mm	1
IB Ø66/72		1
K80/50/3		1
TPA-FZ 5,0T		4





MATERIAAL EIGENSCHAPPEN	
Wapening:	BE500TS/BE500ES
Sterkteklasse beton:	C50/60
Omgevingsklasse:	EE3
Betondekking:	30mm

SF22-0128-BO	
Locinox	
8790 Waregem	

STADSBADER

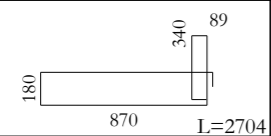
N.V. STADSBADER S.A.
Kanaalstraat 1, B-8530 Harelbeke
info@stadsbader.com - www.stadsbader.com

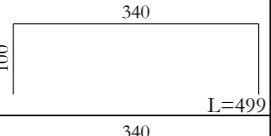
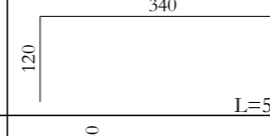
DATUM:	19/10/22	MERK:	40I10S2169
GETEKEND:	TB	AANTAL:	1
GEWICHT:	7.98 ton	DIKTE:	400 mm
OPPERVLAKTE:	11.50 m ²	INDEX:	
VOLUME:	3.19 m ³	DATUM:	

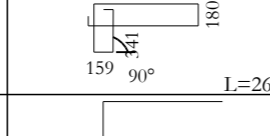
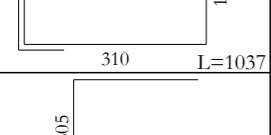
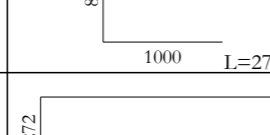
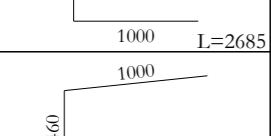
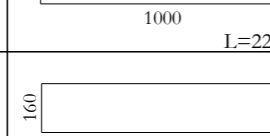
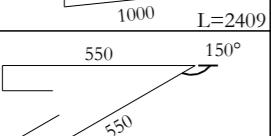
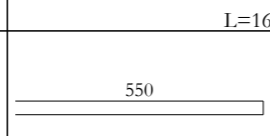
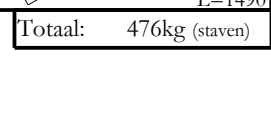
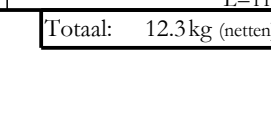
WAPENINGSBORDEREL							
Nummer	#	type net					
(N5***	1	5-100/5-100					
Nummer	#	Ø	Plooivorm	Nummer	#	Ø	Plooivorm
(5716)	1	Ø25	11270	(5717)	2	Ø32	11270
(5718)	8	Ø10	11370	(5719)	2	Ø16	11675
(5720)	4	Ø10	11675	(5721)	2	Ø10	11520
(5709)	63	Ø8		(5710)	2	Ø8	
(5711)	21	Ø8		(5712)	20	Ø8	
(5713)	17	Ø8		(5714)	2	Ø8	
(5715)	2	Ø8		(5722)	2	Ø20	
(5723)	2	Ø20		(5724)	4	Ø10	
(5725)	4	Ø10		(6308)	11	Ø8	
(FR10)	4	Ø16		(FR11)	16	Ø8	
Totaal:			476kg (staven)	Totaal:			12.3kg (netten)

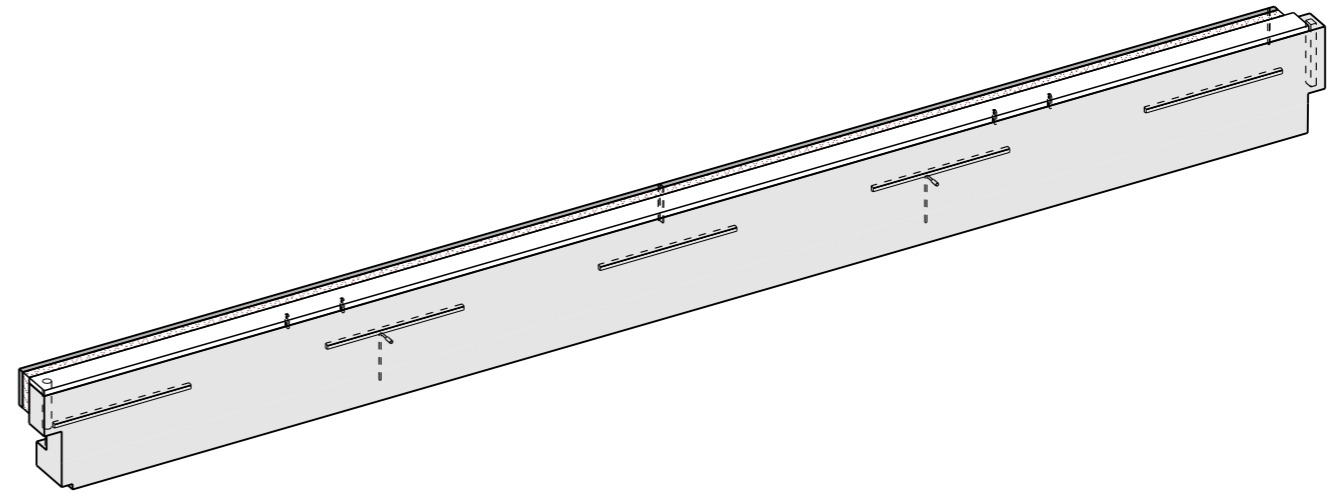

Binnenblad: C50/60	netto opp.: 4.6m ²	V = 1.12 m ³
Binnenblad: C50/60	netto opp.: 7.7m ²	V = 1.84 m ³
Buitenblad: Anthraciet nr. 180	V = 0.23 m ³	
Isolatie:	PIR 022 / 100 mm	
Isolatie:	PIR 022 / 240 mm	

TOEBEHORENLIJST			MATERIAAL EIGENSCHAPPEN	
PSA Ø16/M20	600mm	2	Wapening:	BE500TS/BE500ES
Stabox 45S1 Ø8/150	1250mm	5	Sterkteklasse beton:	C50/60
VV1	330mm	1	Omgevingsklasse:	EE3
VV4	330mm	1	Betondekking:	30mm
IB Ø66/72		1		
K80/50/3		1		
TPA-FZ 5,0T		4		

SF22-0128-BO	
Locinox	
8790 Waregem	

STADSBADER	
N.V. STADSBADER S.A.	
Kanaalstraat 1, B-8530 Harelbeke	
info@stadsbader.com - www.stadsbader.com	

DATUM:	19/10/22	MERK:	40I10S2169
GETEKEND:	TB	AANTAL:	1
GEWICHT:	7.98 ton	DIKTE:	400 mm
OPPERVLAKTE:	11.50 m ²	INDEX:	
VOLUME:	3.19 m ³	DATUM:	