

ISOMETRICO VIGA CAJÓN EJE 5
Esc: 1:30

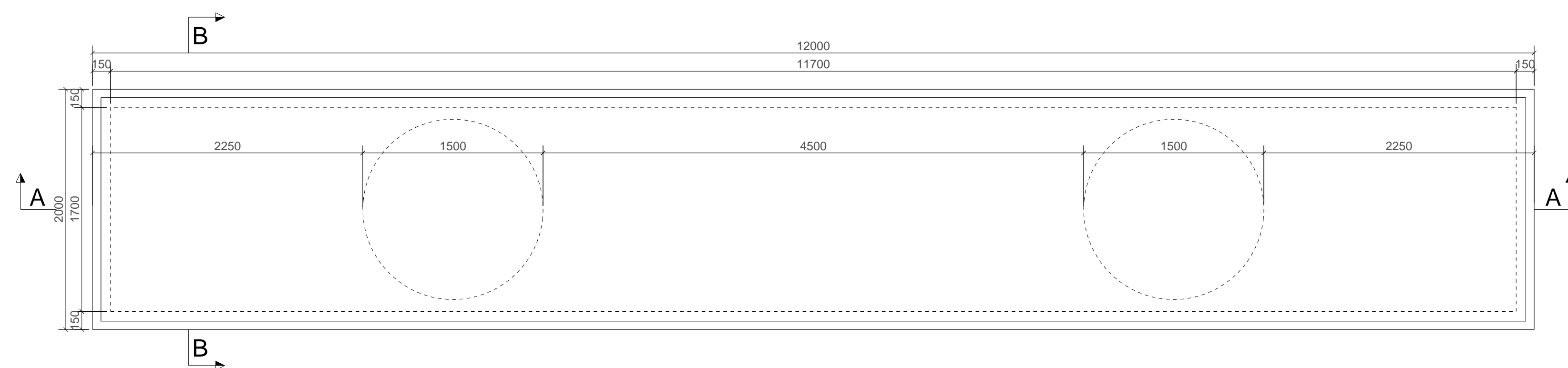

VISTA PLANTA - VIGA CAJÓN EJE 5
Esc: 1:30

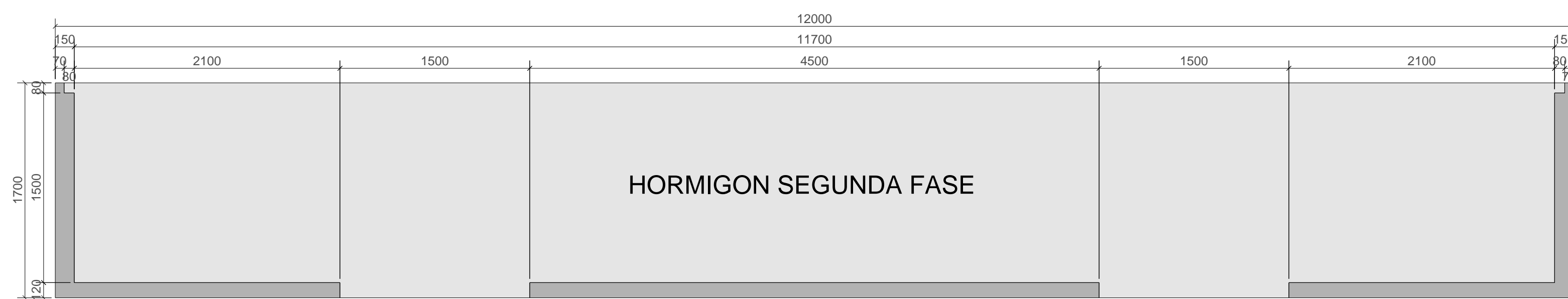

CORTE A - A
Esc: 1:30



CORTE B - B
Esc: 1:20

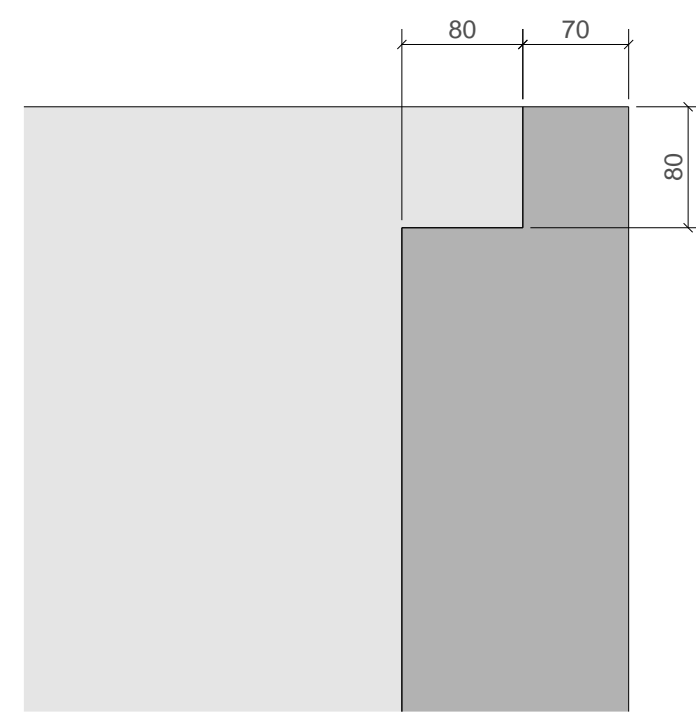

DETALLE B
Esc: 1:5

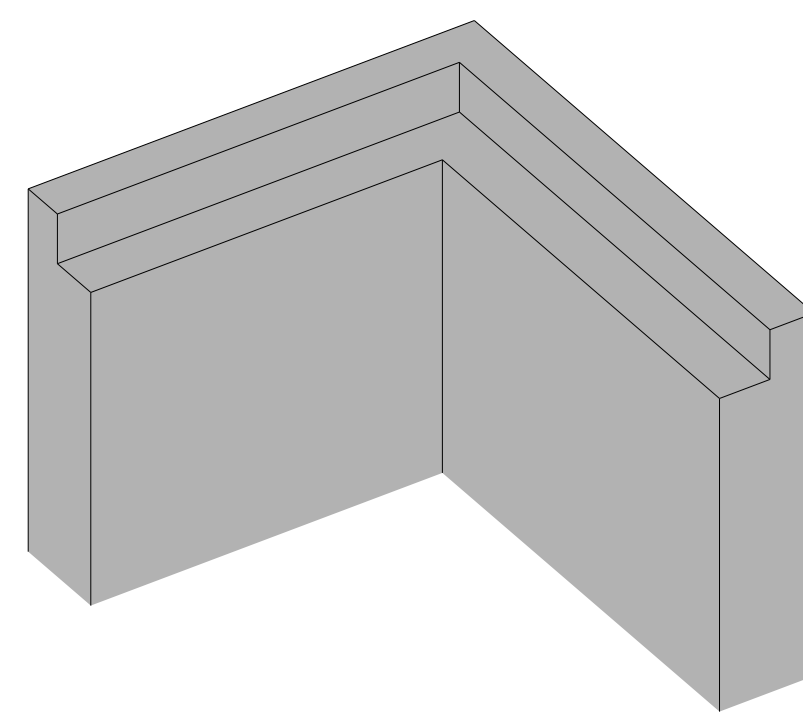

DETALLE A
Esc: 1:10

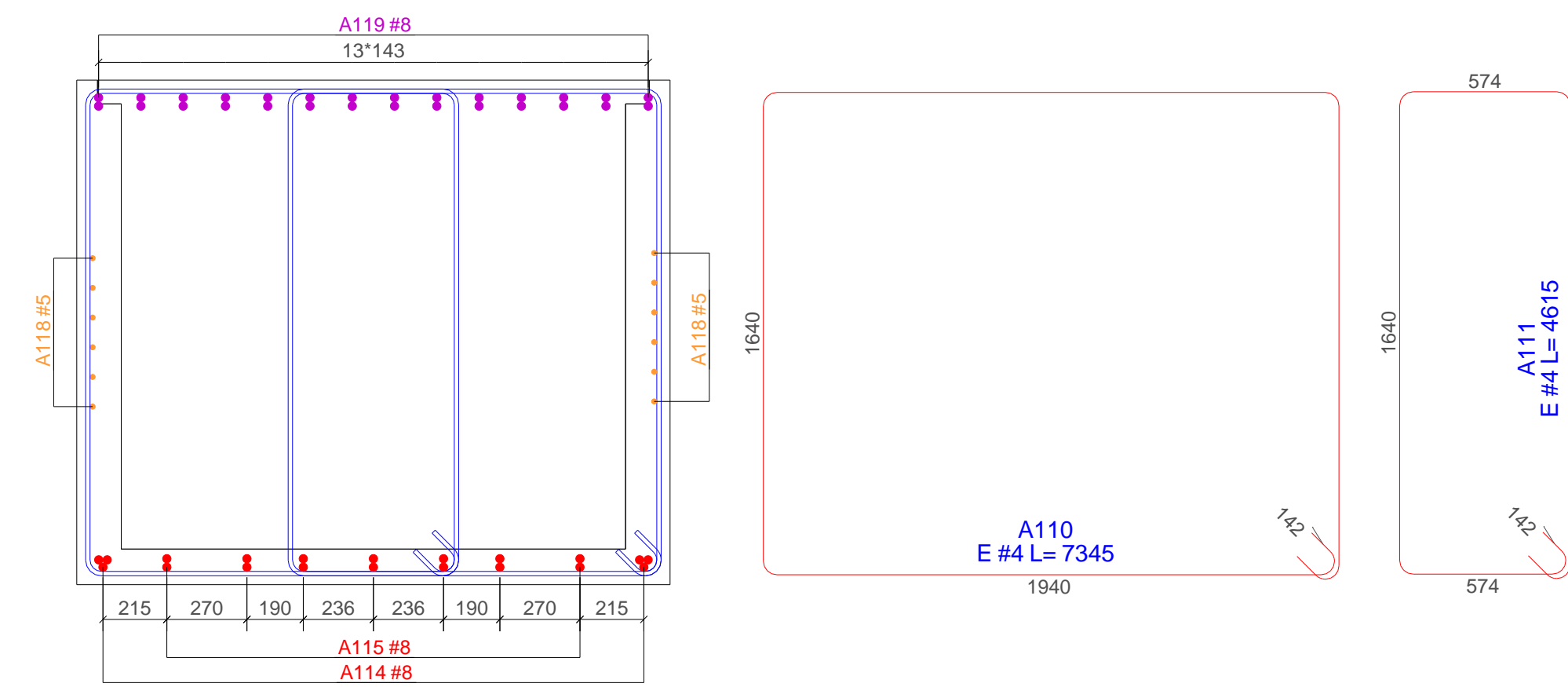

CORTE C - C
Esc: 1:20

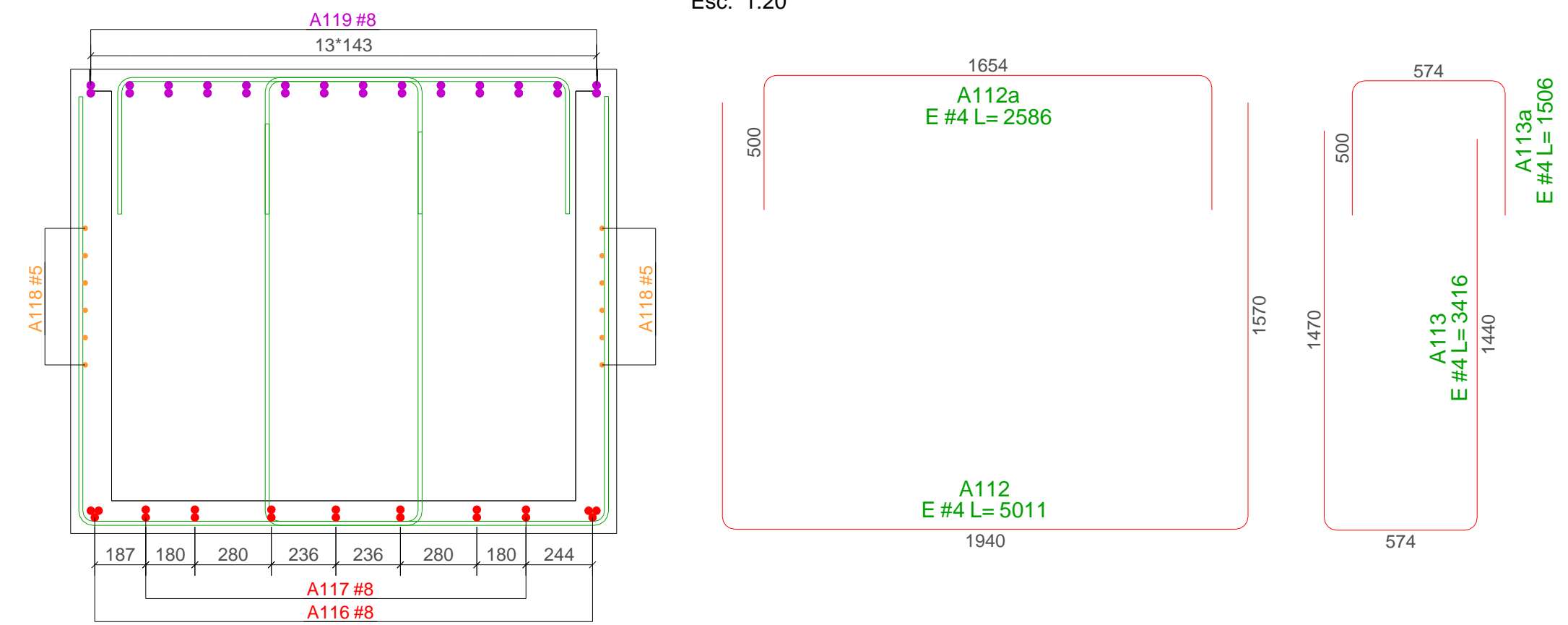

CORTE D - D
Esc: 1:20

BARRAS CON FORMA DE PLEGADO									
Tipo	N. Uds.	Volumen (m³)	Peso (ton)	Acero (kg)	Malta (kg)	Torones (kg)	Cuántia (kg/m²)		
	8.78	21.94	4173				475.28		
Marca	Diámetro	Cantidad	Material	Longitud	Longitud Total	Peso Total	Separación	Forma plegado	
A110	#4	72	fy=420MPa	7302	525744	525.7	150		
A111	#4	72	fy=420MPa	4570	329040	330.3	150		
A112	#4	8	fy=420MPa	5080	40640	39.9	150		
A112a	#4	8	fy=420MPa	2654	21232	20.6	150		
A113	#4	8	fy=420MPa	3484	27872	27.2	150		
A113a	#4	8	fy=420MPa	1574	12592	12.0	150		
A114	#8	12	fy=420MPa	5418	65016	255.1	1823		
A115	#8	28	fy=420MPa	5818	162904	639.8	270		
A116	#8	6	fy=420MPa	6000	36000	143.0	1823		
A117	#8	14	fy=420MPa	4200	58800	233.6	180		
A118	#5	24	fy=420MPa	6373	200952	310.4	100		
A119	#8	56	fy=420MPa	7418	415408	1635.6	143		
Peso Total barras:							4173		

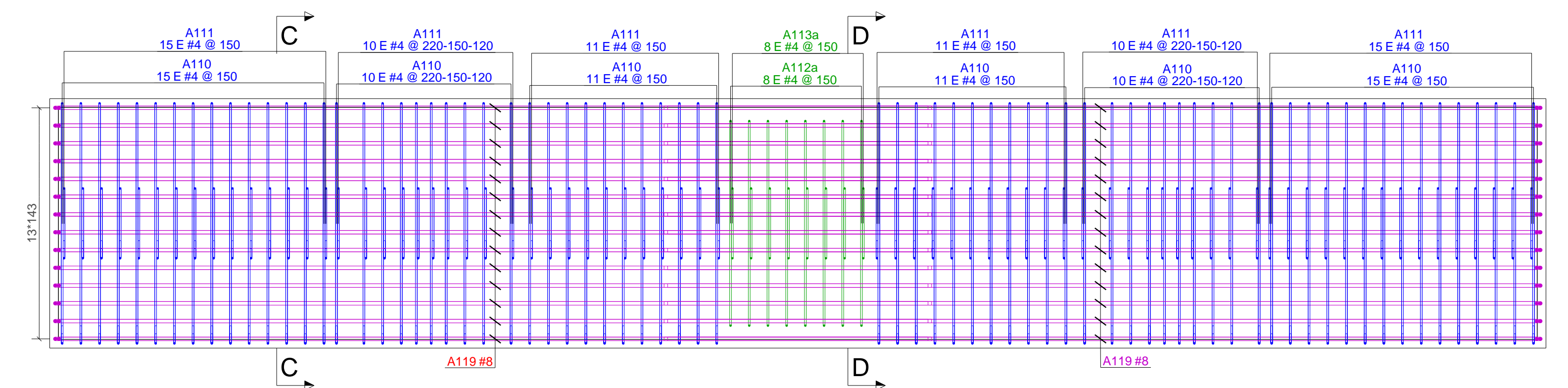

REFUERZO - VISTA SUPERIOR VIGA CAJÓN EJE 5
Esc: 1:30

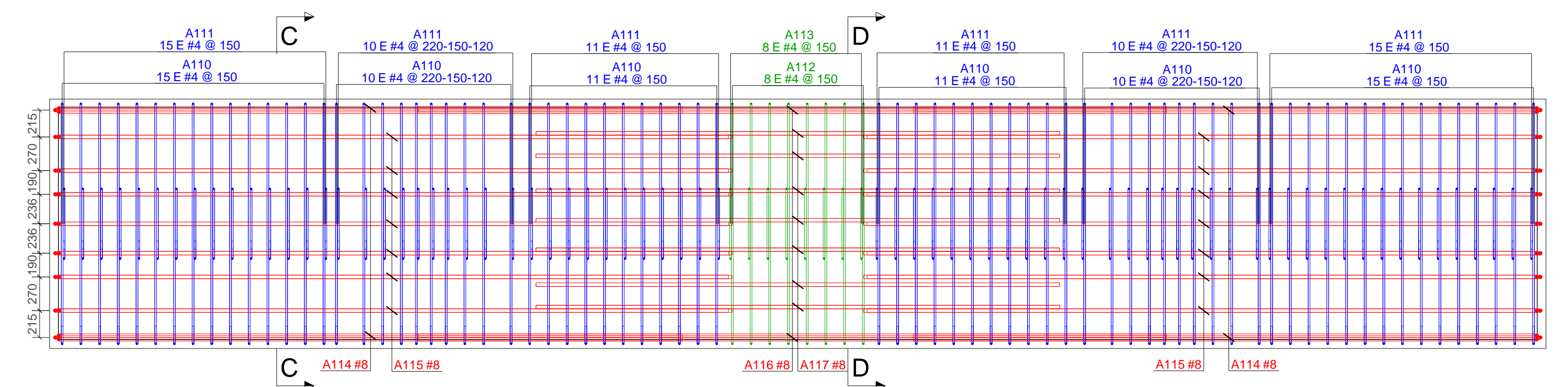

REFUERZO - VISTA INFERIOR VIGA CAJÓN EJE 5
Esc: 1:30

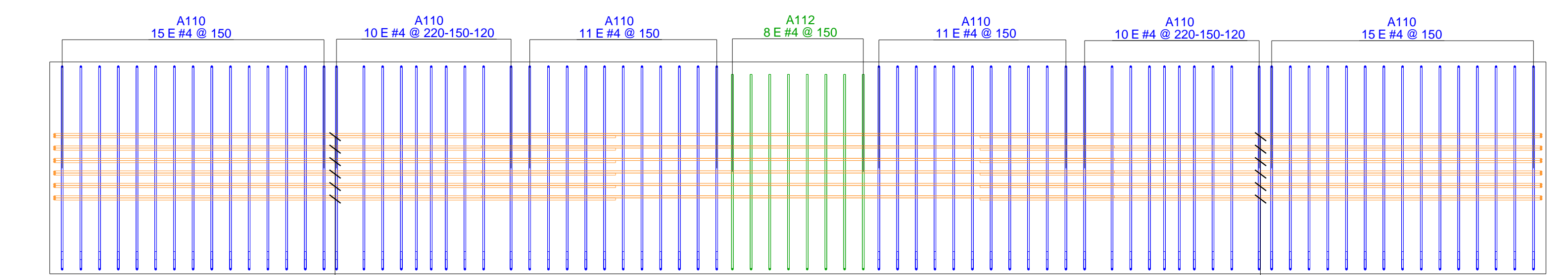

REFUERZO - VISTA LATERAL VIGA CAJÓN EJE 5
Esc: 1:30