

LOCATION					
MARK	QTY	T.O.S	GRID REF	ZONE	REF.
11115	1	7254-3'34	GA2-A3AL	11	E102

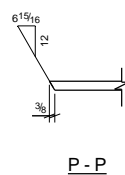

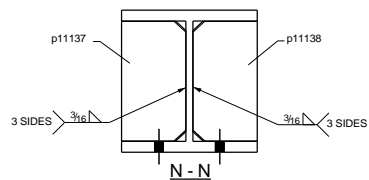
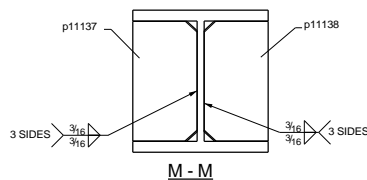
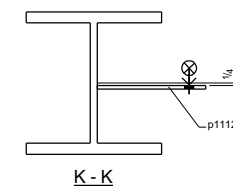
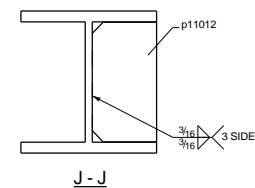
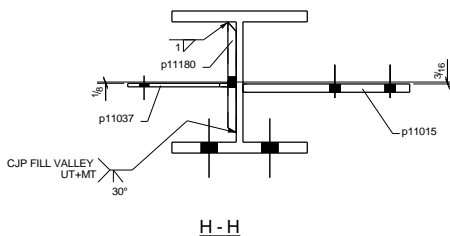
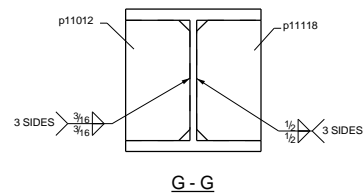
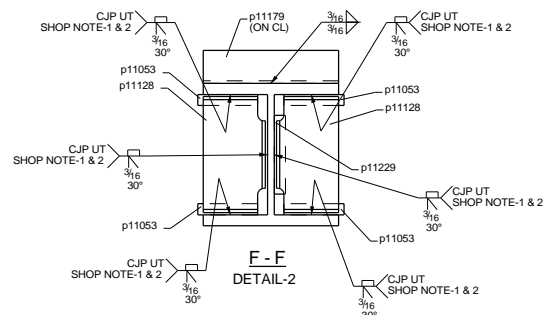
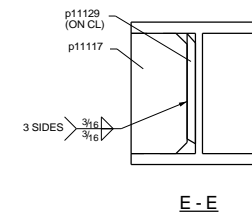
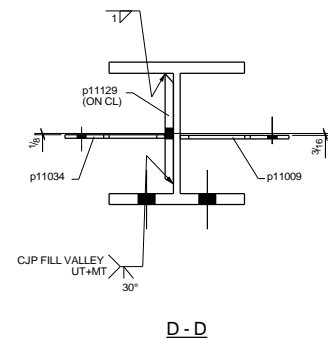
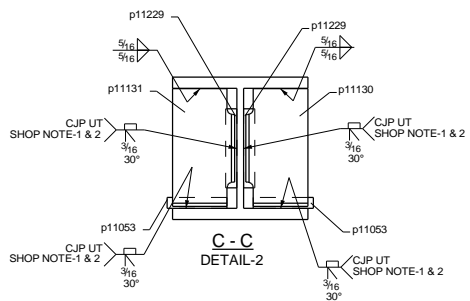
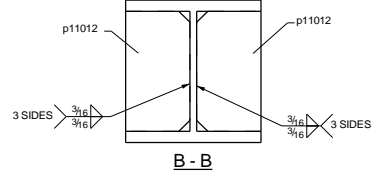
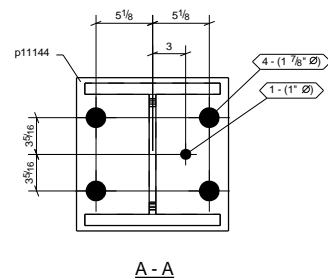

WORK THIS DWG WITH-11115

1 COLUMN MARK: 11115

Profile	d	b	t	w	k
W12X106	12 7/8"	12 1/4"	1 1/4"	5/8"	1 7/8"

HOLE PATTERNS NOTED "SLIP CRITICAL" SHALL BE TO BE DRILLED TO PERFORM TO SAFETY AS CONSTRUCTION. THE CORRECT SURFACE CONNECTION SHALL BE CONSIDERED BY THE FABRICATOR. REFER TO THE DRAWING FOR THE CORRECT SURFACE CONNECTION. REFER TO THE DRAWING FOR THE CORRECT SURFACE CONNECTION. REFER TO THE DRAWING FOR THE CORRECT SURFACE CONNECTION.

PAINT TYPE	
NO PAINT	NO PAINT
SP-3	SP-3

11/02/2023	RELEASED FOR FABRICATION
NO BACK CHARGES WILL BE ACCEPTED WITHOUT PRIOR AUTHORIZATION IN WRITING	
NOTE:	
	
MATERIAL: A992 (U.N.O.)	SSPC: SP-3
BOLT: A325 (U.N.O.)	WELD: 3/16" (U.N.O.)
HOLE SIZE: 13/16"	ELECTRODE: E7018 OR E71T
 	
JOB NAME & LOCATION: VP2 - YELLOWSTONE CLUB VILLAGE PHASE 2 - BLDG.5 1 Yellowstone Club Trail, Big Sky, MT59716	
ARCH: Hart Howerton	ENGR: DCI - Engineers
CONTR: TBD	
REF: E1102	JOB NO: 2252
DRAWN BY: HS 05/11/2023	CHECKED BY: RHB 05/11/2023
SHEET TITLE: COLUMN	DWG. NO: 11115-1