

ZESTAWIENIE ZESPÓŁÓW BETONOWYCH			
Nr poz.	Sztrak	Nazwa	Przebieg/objętość [m³]
F11	10	FUNDAMENT	700x500x150
F12	48	FUNDAMENT	1035x700x150
PK1	177	PODKŁAD KOLEJOWY	250x150 L=2900

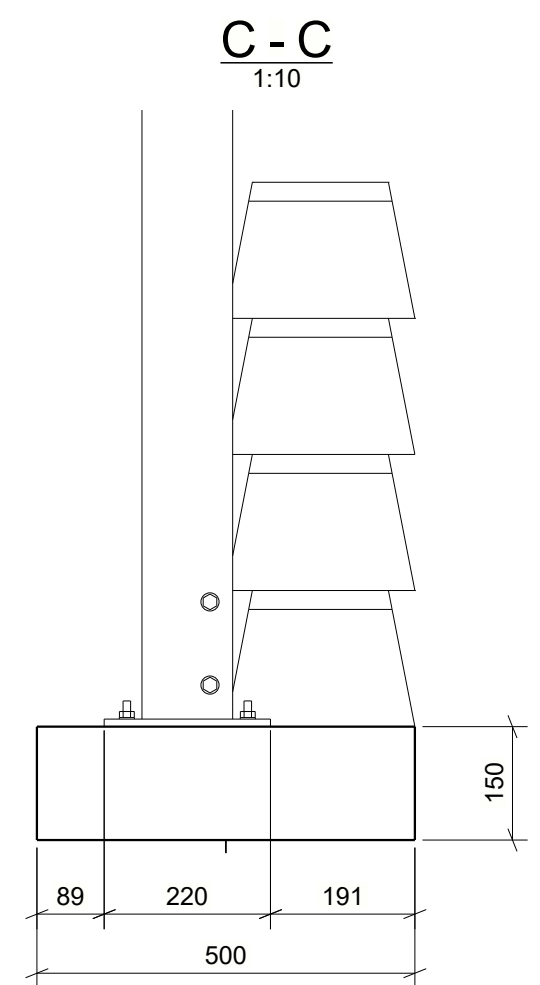
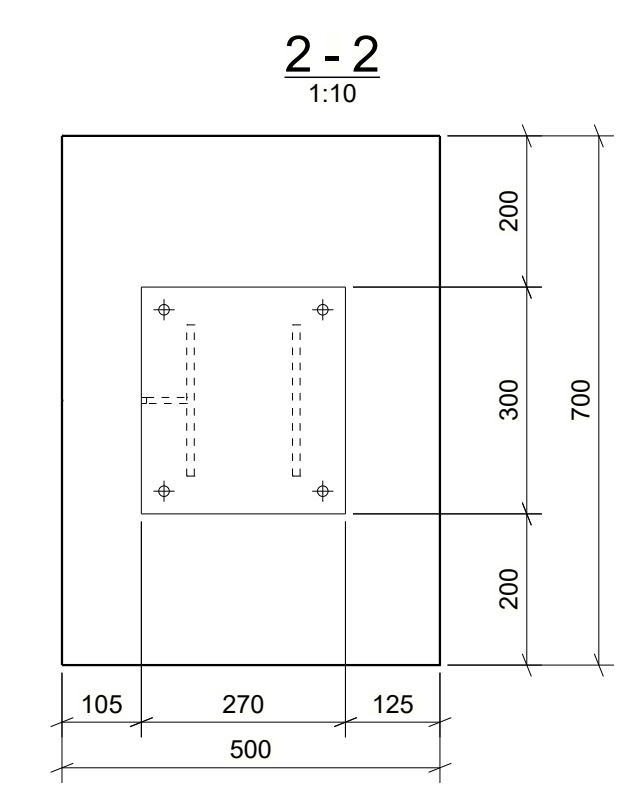
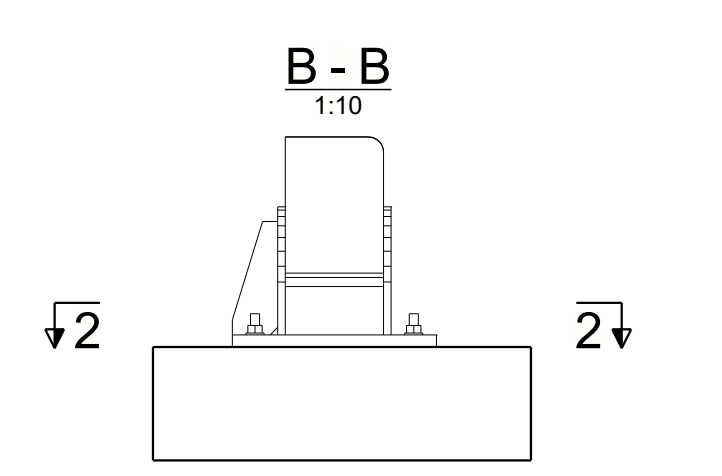
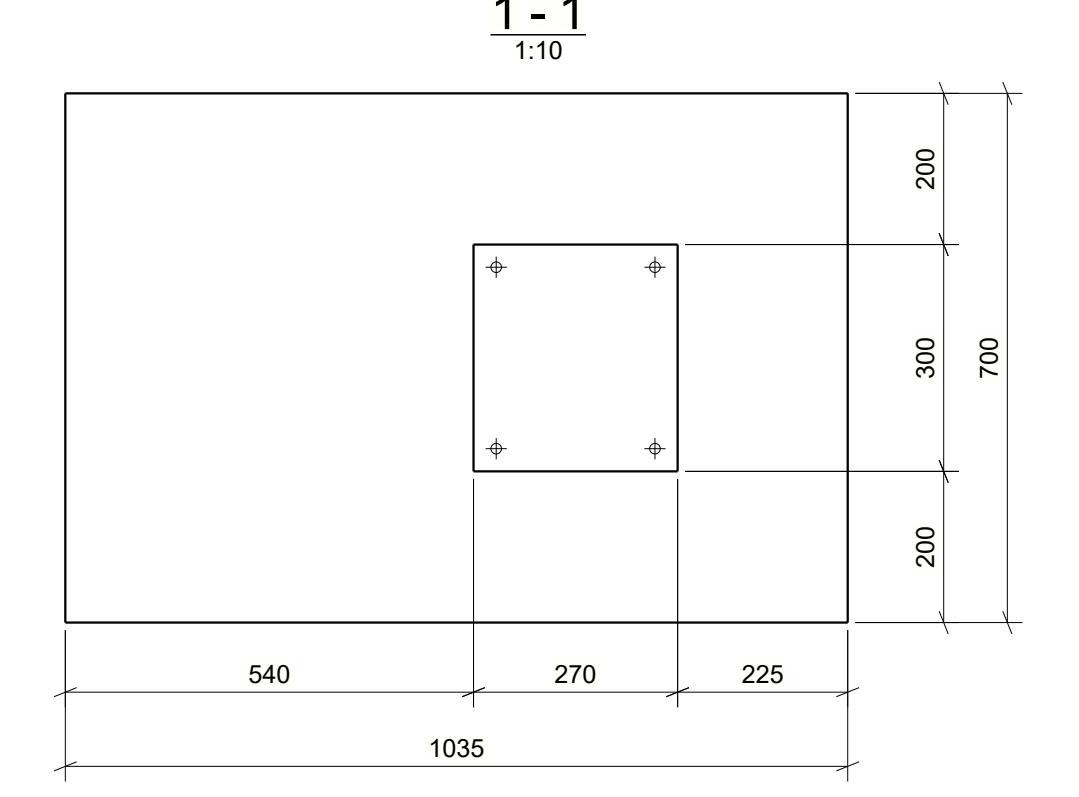
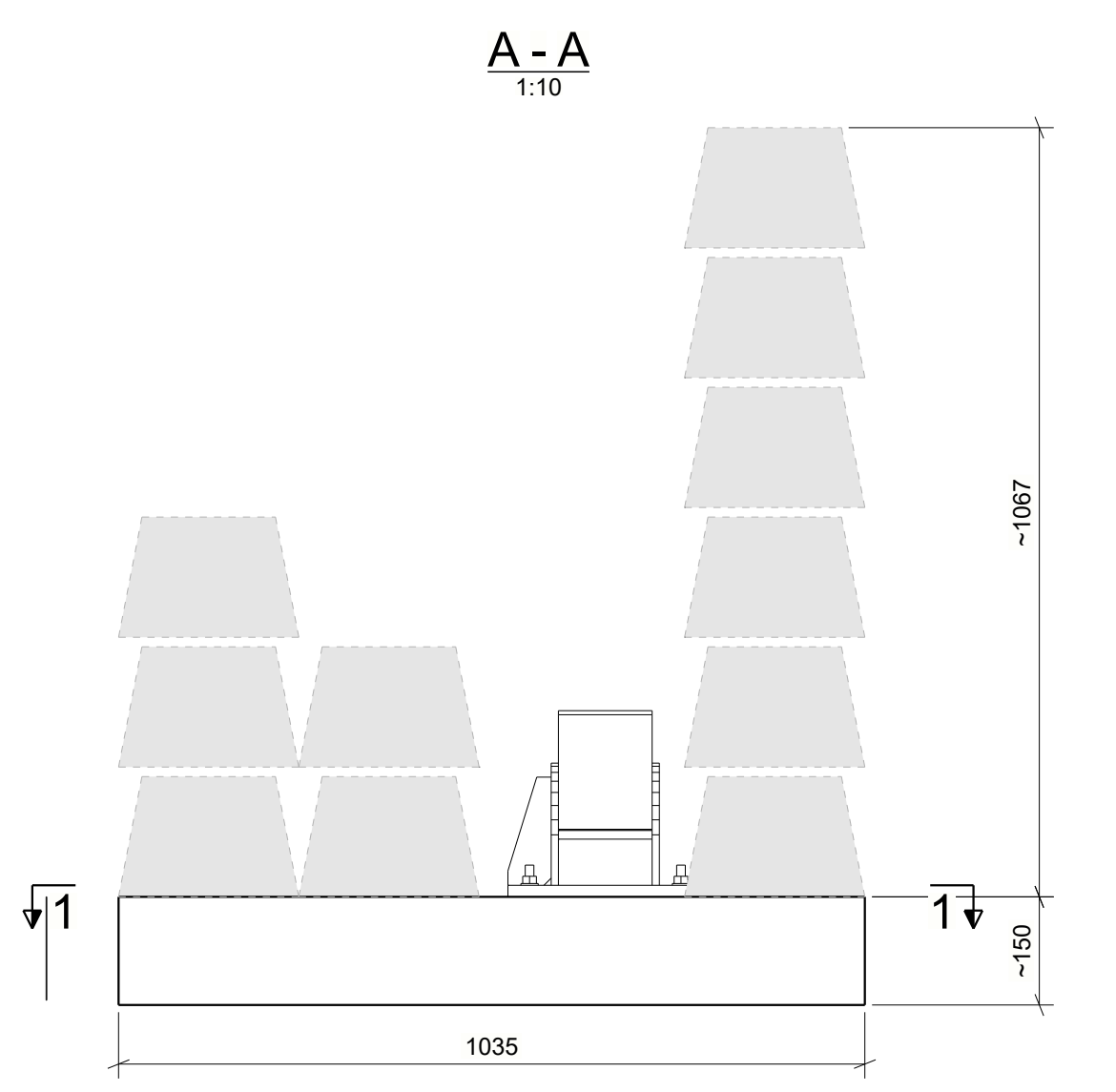
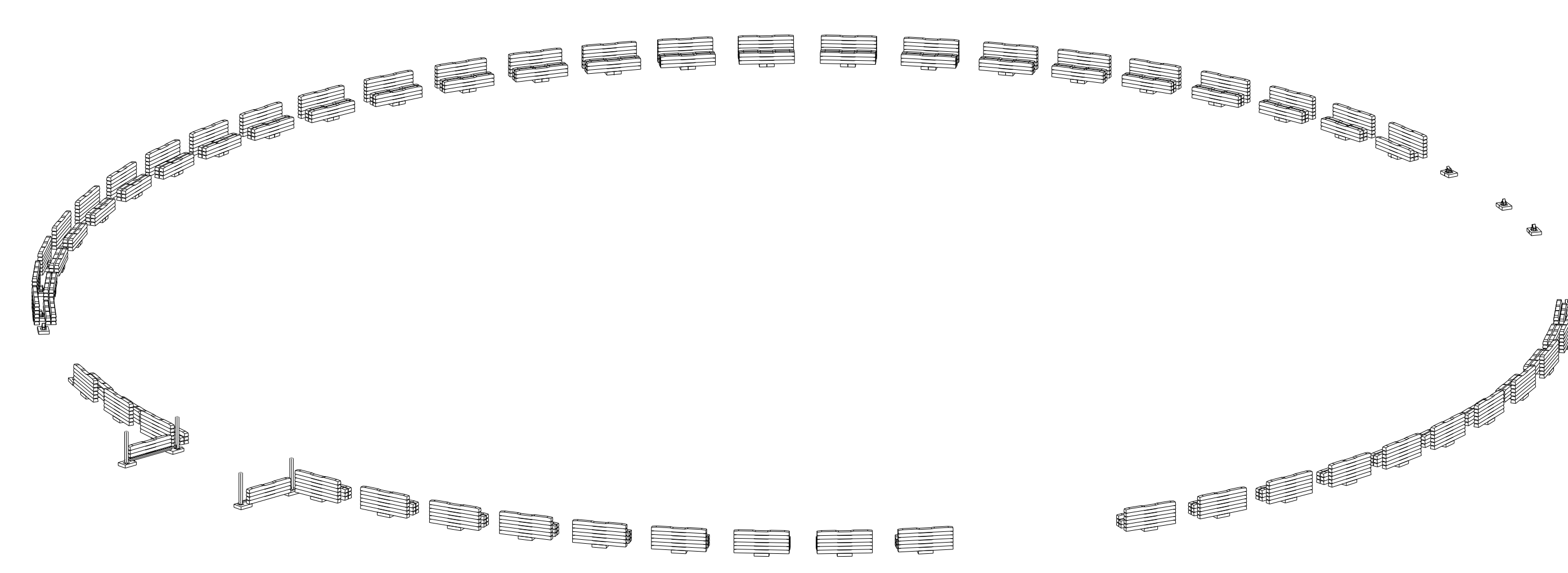
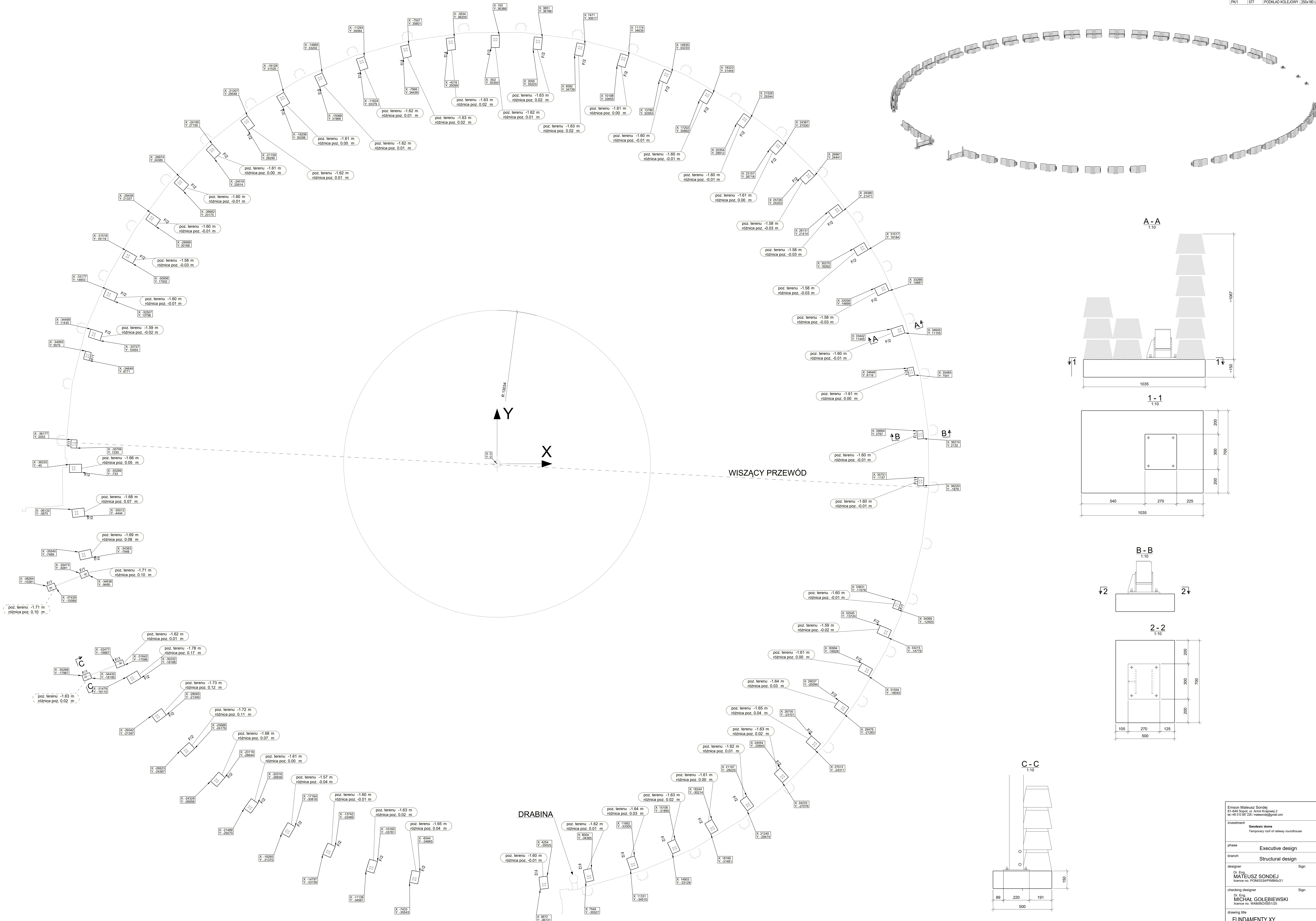

Inwestycja: Geodesic dome Temporary roof of railway roundhouse	
phase	Executive design
branch	Structural design
designer	Dr. Eng. MATEUSZ SONDEJ licencja nr. PDM/0334/PW/06/21
checking designer	Dr. Eng. MICHAŁ GOLEBIEWSKI licencja nr. WAM/03/05/12
drawing title: FUNDAMENTY XY	
date	27/11/2025
scale	1:10 1:100
drawing no.	GA-102
rev.	